

Features

- Low On resistance.
- 4.5V drive.
- RoHS compliant.

Package Dimensions

TO-252-5 Unit: mm(inch)

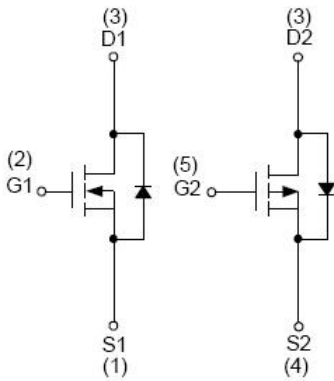
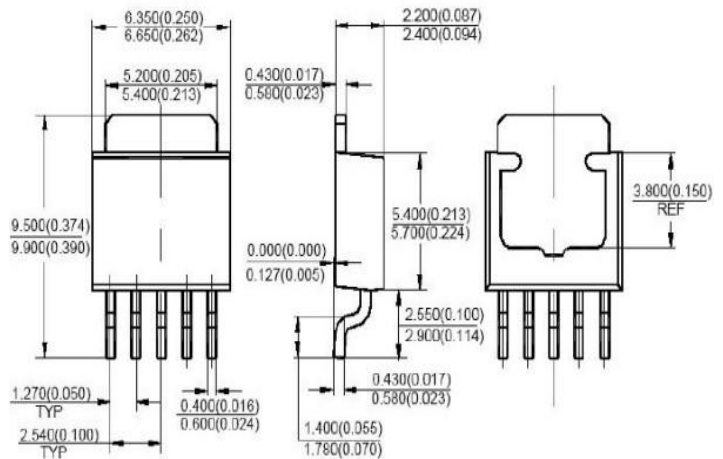
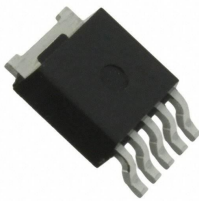

N-Channel MOSFET

P-Channel MOSFET

Specifications

Absolute Maximum Ratings at $T_a=25^{\circ}\text{C}$

Parameter	Symbol	Conditions	N-Ch	P-Ch	Unit
Drain-to-Source Voltage	V_{DSS}		60	-60	V
Gate-to-Source Voltage	V_{GSS}		± 25	± 25	V
Drain Current (DC)	I_{D}		16	-12	A
Drain Current (Pulse)	I_{DP}	$PW \leq 10\mu\text{s}$, duty cycle $\leq 1\%$	28	25	A
Allowable Power Dissipation	P_{D}	Mounted on a ceramic board	30	30	W

Si6618

		(1000mm ² ×0.8mm) 1unit			
Total Dissipation	P _T	Mounted on a ceramic board (1000mm ² ×0.8mm)	5	5	W
Avalanche Energy	E _{AS}	T _J =25°C, V _{DS} =20V, V _{GS} =10V	58	58	mJ
Channel Temperature	T _{ch}		150	150	°C
Storage Temperature	T _{stg}		-55~+150	-55~+150	°C

Electrical Characteristics (N-Channel) at T_a=25°C

Parameter	Symbol	Conditions	Ratings			Unit
			min	typ	max	
Drain-to-Source Breakdown Voltage	V _{(BR)DSS}	I _D =250uA, V _{GS} =0V	60	-	-	V
Zero-Gate Voltage Drain Current	I _{DSS}	V _{DS} =60V, V _{GS} =0V	-	-	1	uA
Gate-to-Source Leakage Current	I _{GSS}	V _{GS} =±20V, V _{DS} =0V	-	-	±100	nA
Gate Threshold Voltage	V _{GS(th)}	V _{DS} =V _{GS} , I _D =250uA	1	1.8	2.5	V
Static Drain-to-Source On-State Resistance	R _{DS(ON)}	I _D =12A, V _{GS} =10V	-	-	40	mΩ
	R _{DS(ON)}	I _D =7A, V _{GS} =4.5V	-	-	50	mΩ
Input Capacitance	C _{iss}	V _{DS} =15V, V _{GS} =0V, f=1MHz	-	880	-	pF
Output Capacitance	C _{oss}	V _{DS} =15V, V _{GS} =0V, f=1MHz	-	140	-	pF
Reverse Transfer Capacitance	C _{rss}	V _{DS} =15V, V _{GS} =0V, f=1MHz	-	90	-	pF
Turn-on Delay Time	t _{d(on)}	V _{DS} =15V, R _L =0.75Ω, R _{GEN} =1Ω, V _{GS} =10V	-	13	-	nS
Rise Time	t _r		-	18	-	nS
Turn-off Delay Time	t _{d(off)}		-	30	-	nS
Fall Time	t _f		-	11	-	nS
Total Gate Charge	Q _g	V _{DS} =15V, V _{GS} =10V, I _D =20A	-	24	-	nC
Gate-to-Source Charge	Q _{gs}		-	20	-	nC
Gate-to-Drain “Miller” Charge	Q _{gd}		-	27	-	nC
Diode Forward Voltage	V _{SD}	I _S =3A, V _{GS} =0V	-	0.75	-	V

Electrical Characteristics (P-Channel) at T_a=25°C

Parameter	Symbol	Conditions	Ratings			Unit
			min	typ	max	
Drain-to-Source Breakdown Voltage	V _{(BR)DSS}	I _D =250uA, V _{GS} =0V	-60	-	-	V
Zero-Gate Voltage Drain Current	I _{DSS}	V _{DS} =60V, V _{GS} =0V	-	-	-1	uA
Gate-to-Source Leakage Current	I _{GSS}	V _{GS} =±20V, V _{DS} =0V	-	-	±100	nA
Gate Threshold Voltage	V _{GS(th)}	V _{DS} =V _{GS} , I _D =250uA	-1	-	-2.5	V
Static Drain-to-Source On-State Resistance	R _{DS(ON)}	I _D =-5A, V _{GS} =-10V	-	68	80	mΩ
	R _{DS(ON)}	I _D =-3A, V _{GS} =-4.5V	-	80	110	mΩ
Input Capacitance	C _{iss}	V _{DS} =15V, V _{GS} =0V, f=1MHz	-	1120	-	pF
Output Capacitance	C _{oss}	V _{DS} =15V, V _{GS} =0V, f=1MHz	-	190	-	pF
Reverse Transfer Capacitance	C _{rss}	V _{DS} =15V, V _{GS} =0V, f=1MHz	-	100	-	pF
Turn-on Delay Time	t _{d(on)}	V _{DS} =15V, R _L =0.75Ω, R _{GEN} =1Ω, V _{GS} =10V	-	12	-	nS
Rise Time	t _r		-	16	-	nS
Turn-off Delay Time	t _{d(off)}		-	40	-	nS
Fall Time	t _f		-	11	-	nS

Si6618

Total Gate Charge	Q_g	$V_{DS}=15V, V_{GS}=10V, I_D=10A$	-	22	-	nC
Gate-to-Source Charge	Q_{gs}		-	25	-	nC
Gate-to-Drain "Miller" Charge	Q_{gd}		-	30	-	nC
Diode Forward Voltage	V_{SD}	$I_S=3A, V_{GS}=0V$	-	-0.75	-	V

Typical Characteristics (N-Channel) at $T_a=25^{\circ}C$

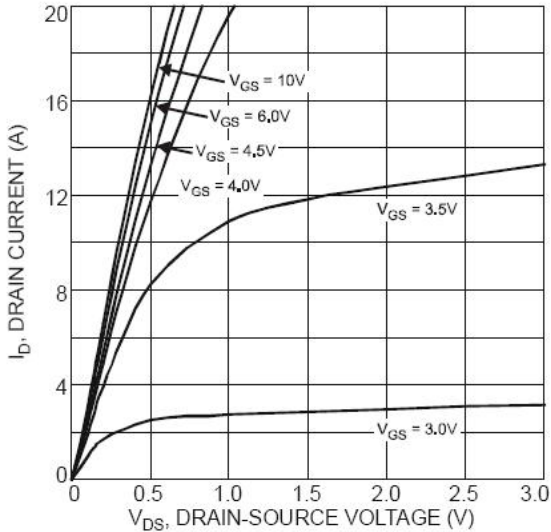

Fig. 1 Typical Output Characteristic

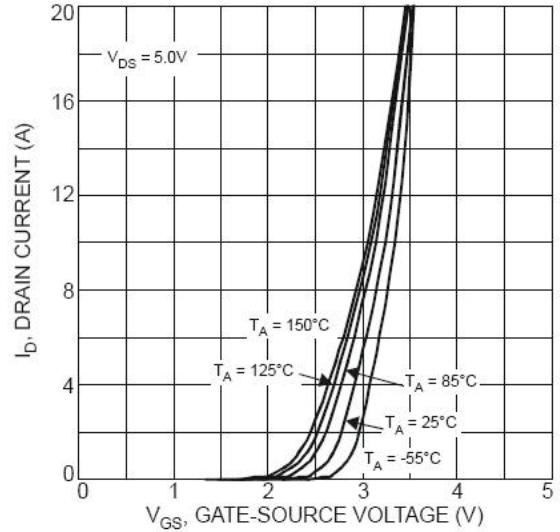

Fig. 2 Typical Transfer Characteristics

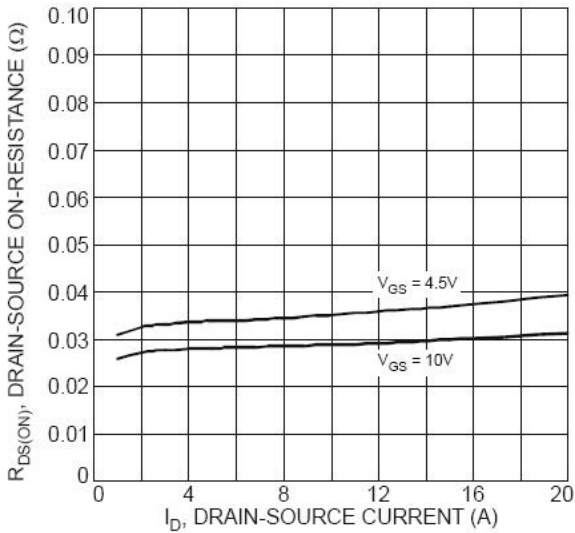

Fig. 3 Typical On-Resistance vs. Drain Current and Gate Voltage

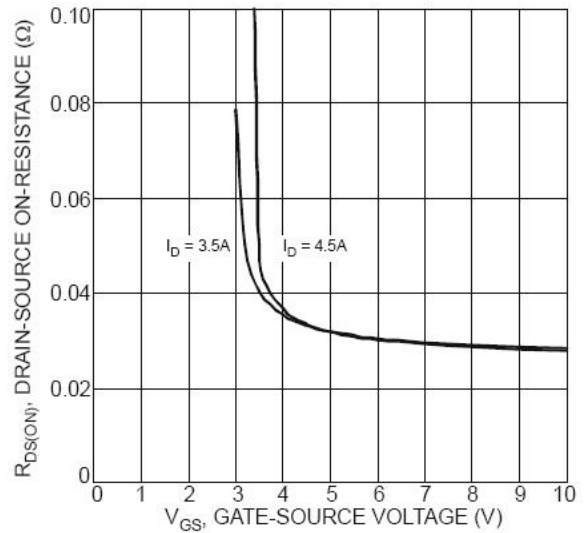

Fig. 4 Typical On-Resistance vs. Drain Current and Gate Voltage

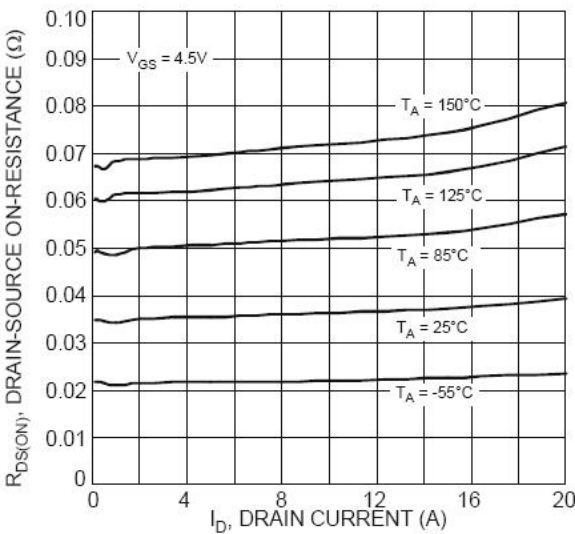

Fig. 5 Typical On-Resistance vs. Drain Current and Temperature

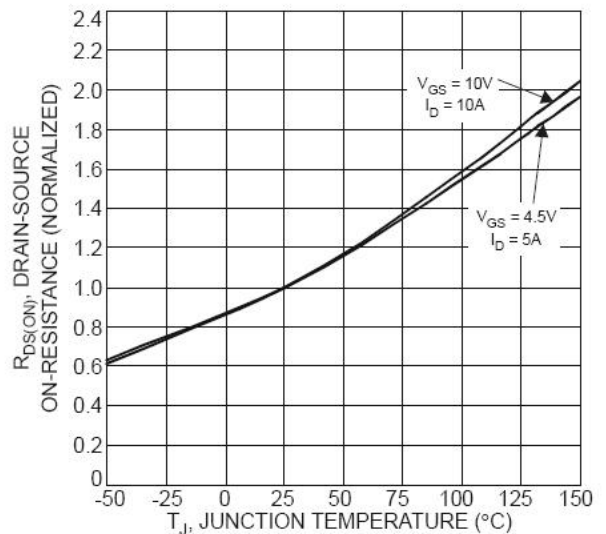

Fig. 6 On-Resistance Variation with Temperature

Typical Characteristics (N-Channel) at $T_a=25^{\circ}\text{C}$ (Continued)

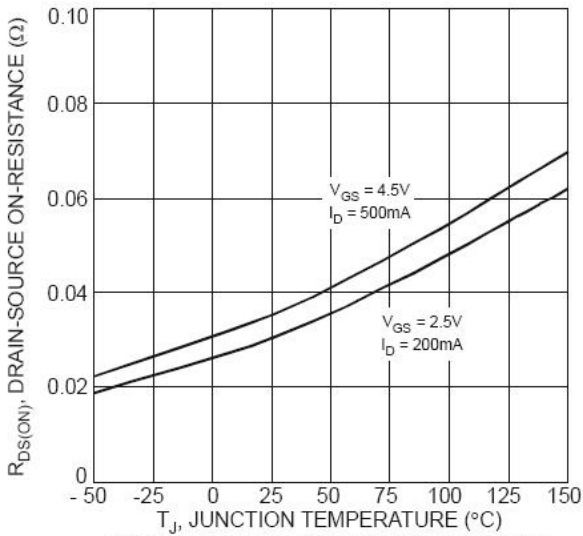

Fig. 7 On-Resistance Variation with Temperature

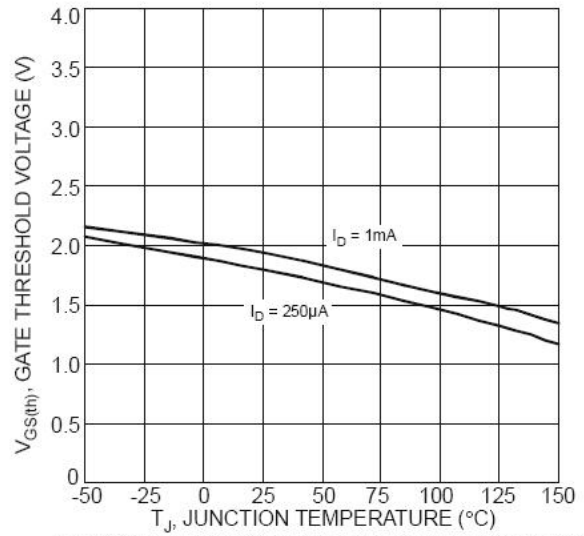

Fig. 8 Gate Threshold Variation vs. Ambient Temperature

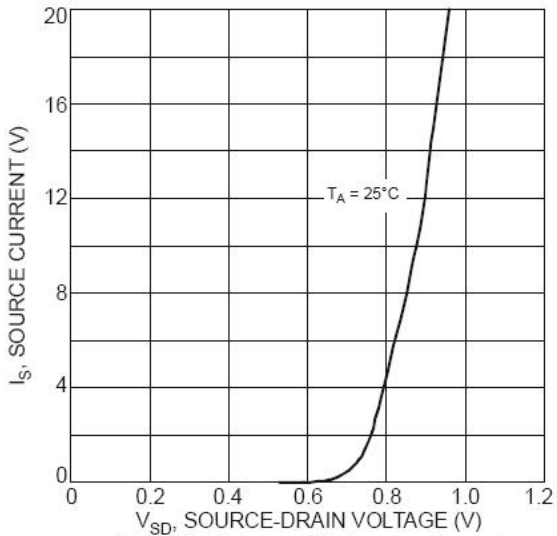

Fig. 9 Diode Forward Voltage vs. Current

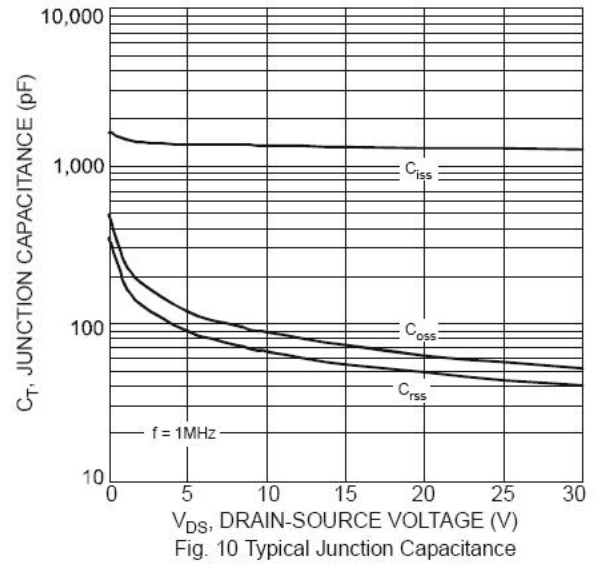

Fig. 10 Typical Junction Capacitance

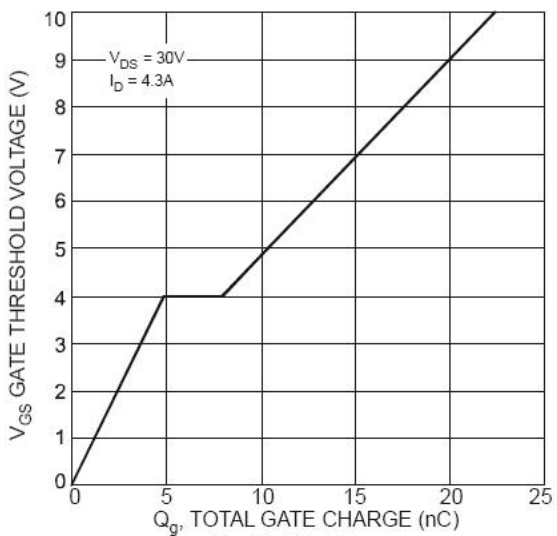

Fig. 11 Gate Charge

Typical Characteristics (P-Channel) at $T_a=25^{\circ}\text{C}$

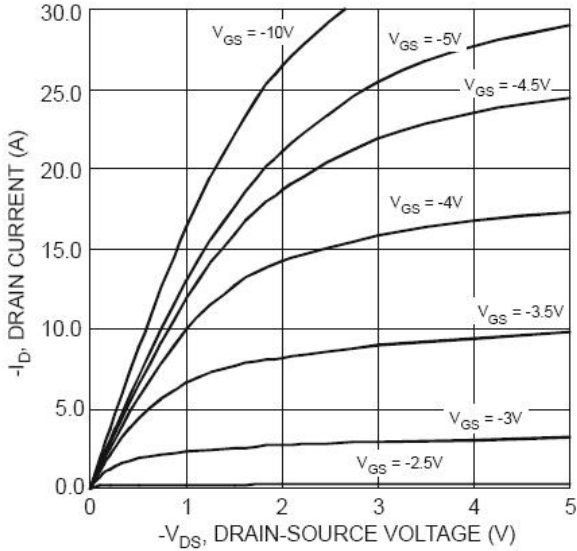

Figure 1 Typical Output Characteristics

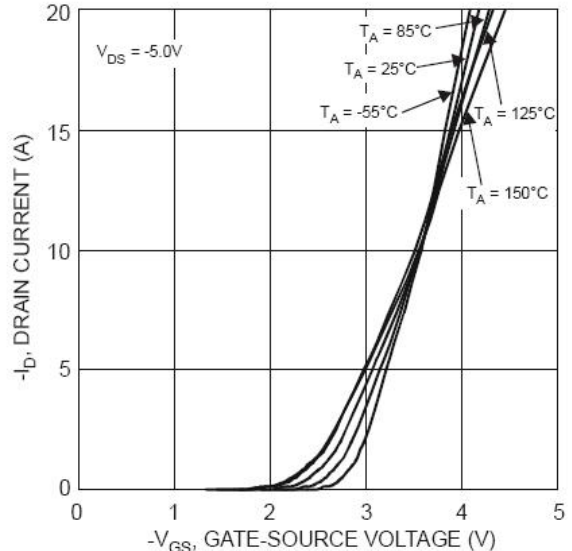

Figure 2 Typical Transfer Characteristics

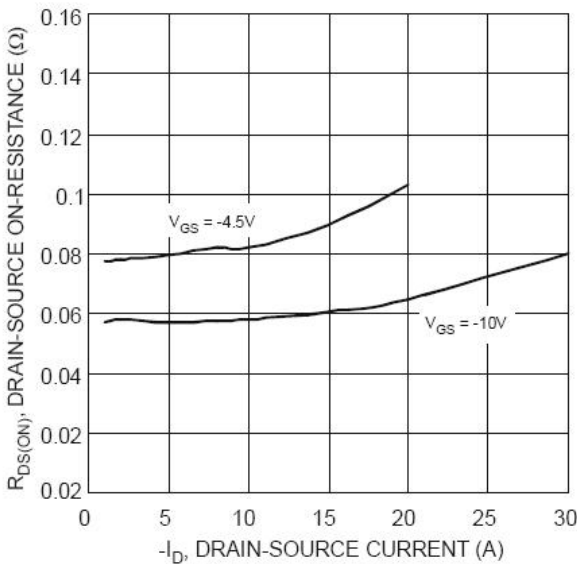

Figure 3 Typical On-Resistance vs. Drain Current and Gate Voltage

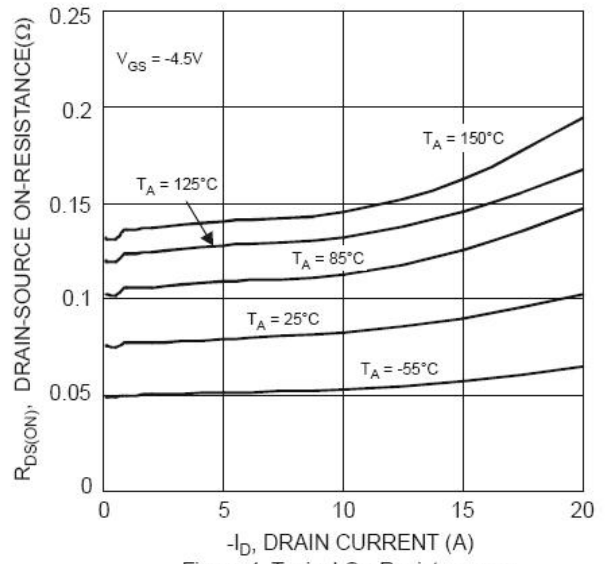

Figure 4 Typical On-Resistance vs. Drain Current and Temperature

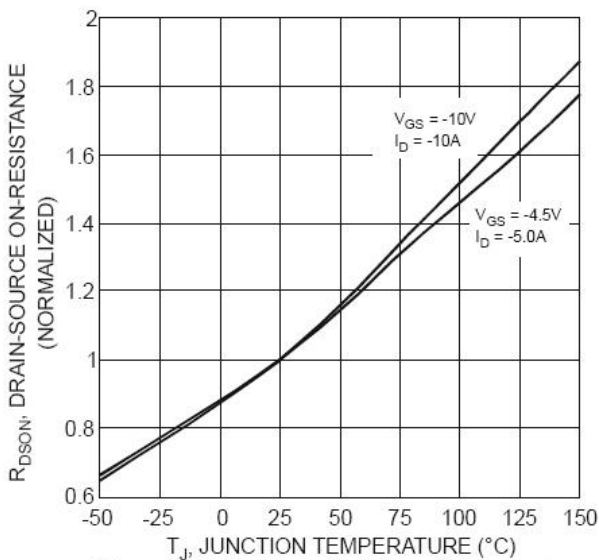

Figure 5 On-Resistance Variation with Temperature

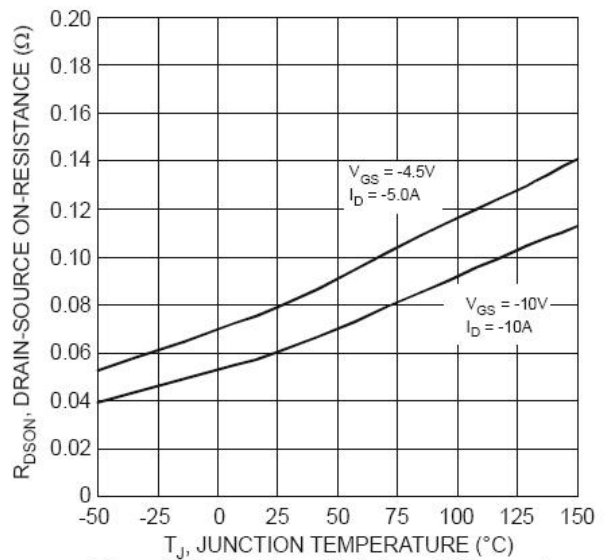

Figure 6 On-Resistance Variation with Temperature

Typical Characteristics (P-Channel) at T_a=25°C (Continued)

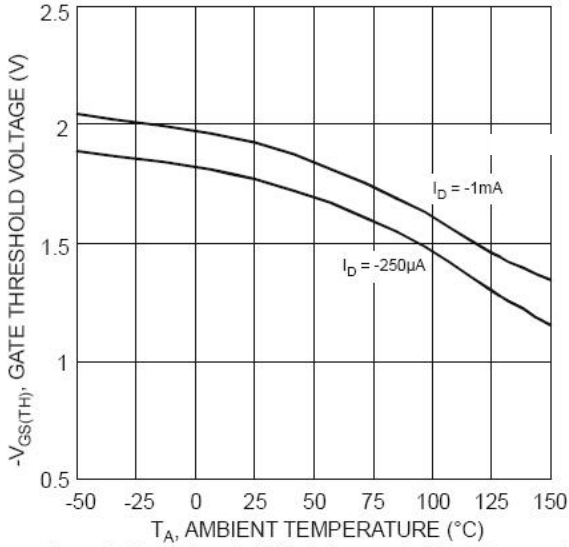

Figure 7 Gate Threshold Variation vs. Ambient Temperature

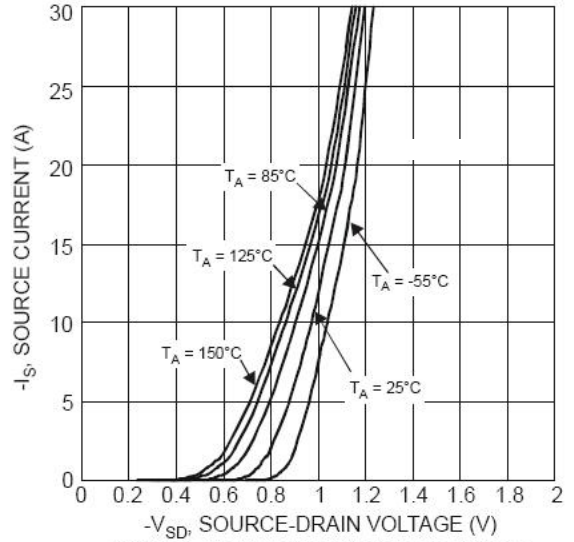

Figure 8 Diode Forward Voltage vs. Current

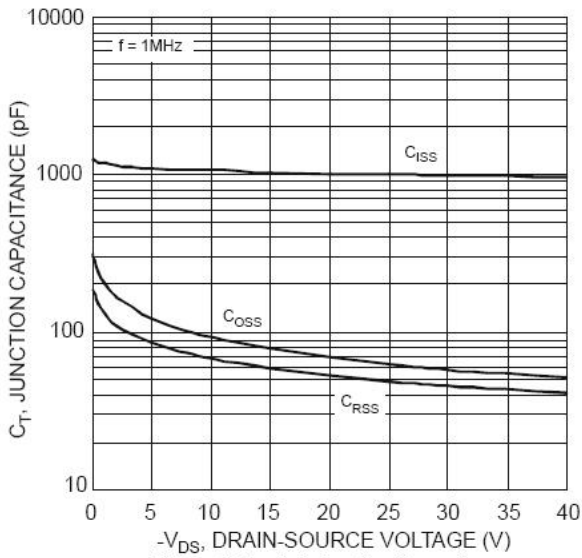

Figure 9 Typical Junction Capacitance

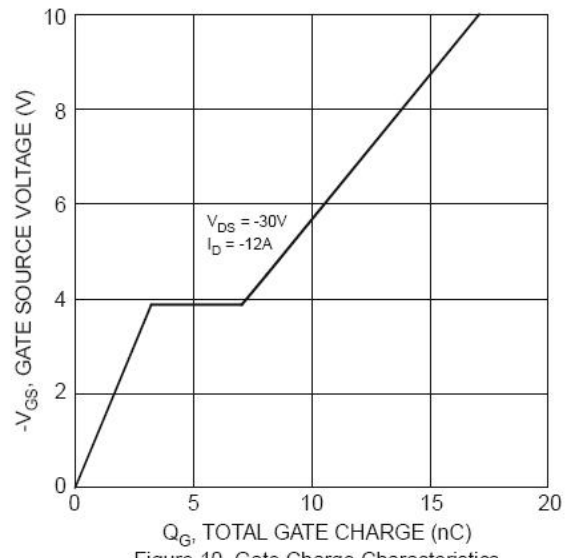

Figure 10 Gate Charge Characteristics