

Features

- Low On resistance.
- -4.5V drive.
- RoHS compliant.

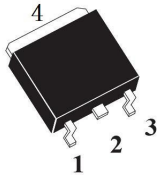

Package Dimensions

TO-252

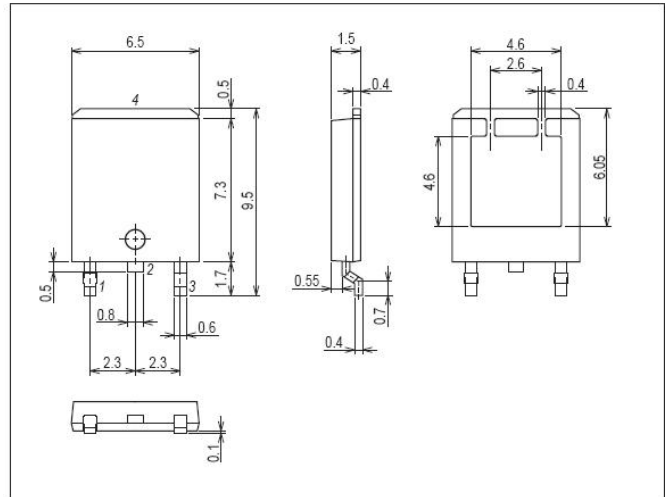

Specifications

Absolute Maximum Ratings at $T_a=25^{\circ}\text{C}$

Parameter	Symbol	Conditions	Ratings	Unit
Drain-to-Source Voltage	V_{DSS}		-40	V
Gate-to-Source Voltage	V_{GSS}		+20	V
Drain Current (DC)	I_D		-15	A
Drain Current (Pulse)	I_{DP}	$PW \leq 10\mu\text{s}$, duty cycle $\leq 1\%$	-28	A
Allowable Power Dissipation	P_D	Mounted on a ceramic board (1000mm ² ×0.8mm) 1unit	30	W
Total Dissipation	P_T	Mounted on a ceramic board (1000mm ² ×0.8mm)	30	W
Channel Temperature	T_{ch}		150	°C
Storage Temperature	T_{stg}		-55~+150	°C

Electrical Characteristics at $T_a=25^{\circ}\text{C}$

Parameter	Symbol	Conditions	Ratings			Unit
			min	typ	max	
Drain-to-Source Breakdown Voltage	$V_{(BR)DSS}$	$I_D = -250\mu\text{A}$, $V_{GS} = 0\text{V}$	-40	-	-	V
Zero-Gate Voltage Drain Current	I_{DSS}	$V_{DS} = -40\text{V}$, $V_{GS} = 0\text{V}$	-	-	-1	uA
Gate-to-Source Leakage Current	I_{GSS}	$V_{GS} = \pm 20\text{V}$, $V_{DS} = 0\text{V}$	-	-	±100	nA
Gate Threshold Voltage	$V_{GS(th)}$	$V_{DS} = V_{GS}$, $I_D = -250\mu\text{A}$	-1	-	-2.5	V
Static Drain-to-Source On-State Resistance	$R_{DS(ON)}$	$I_D = -5\text{A}$, $V_{GS} = -10\text{V}$	-	30	42	mΩ
	$R_{DS(ON)}$	$I_D = -3\text{A}$, $V_{GS} = -4.5\text{V}$	-	49	70	mΩ
Input Capacitance	C_{iss}	$V_{DS} = -30\text{V}$, $V_{GS} = 0\text{V}$, $f = 1\text{MHz}$	-	190	-	pF
Output Capacitance	C_{oss}	$V_{DS} = -30\text{V}$, $V_{GS} = 0\text{V}$, $f = 1\text{MHz}$	-	100	-	pF
Reverse Transfer Capacitance	C_{rss}	$V_{DS} = -30\text{V}$, $V_{GS} = 0\text{V}$, $f = 1\text{MHz}$	-	12	-	pF

Si4015

Electrical Characteristics at $T_a=25^{\circ}\text{C}$ (Continued)

Parameter	Symbol	Conditions	Ratings			Unit
			min	Typ	max	
Turn-on Delay Time	$t_{d(on)}$	$V_{DS}=-30\text{V}$, $I_D=-1.5\text{A}$, $R_{GEN}=1\Omega$, $V_{GS}=10\text{V}$	-	12	-	nS
Rise Time	t_r		-	16	-	nS
Turn-off Delay Time	$t_{d(off)}$		-	40	-	nS
Fall Time	t_f		-	11	-	nS
Total Gate Charge	Q_g	$V_{DS}=-30\text{V}$, $V_{GS}=4.5\text{V}$, $I_D=-3\text{A}$	-	22	-	nC
Gate-to-Source Charge	Q_{gs}		-	25	-	nC
Gate-to-Drain "Miller" Charge	Q_{gd}		-	20	-	nC
Diode Forward Voltage	V_{SD}	$I_S=-3\text{A}$, $V_{GS}=0\text{V}$	-	-0.75	-	V

Typical Characteristics at $T_a=25^{\circ}\text{C}$

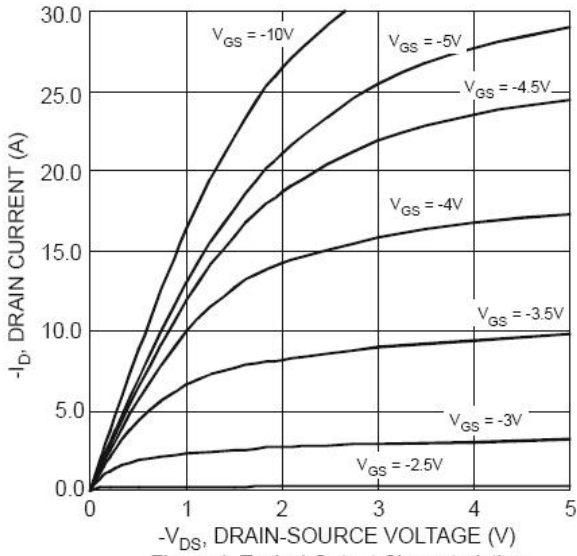

Figure 1 Typical Output Characteristics

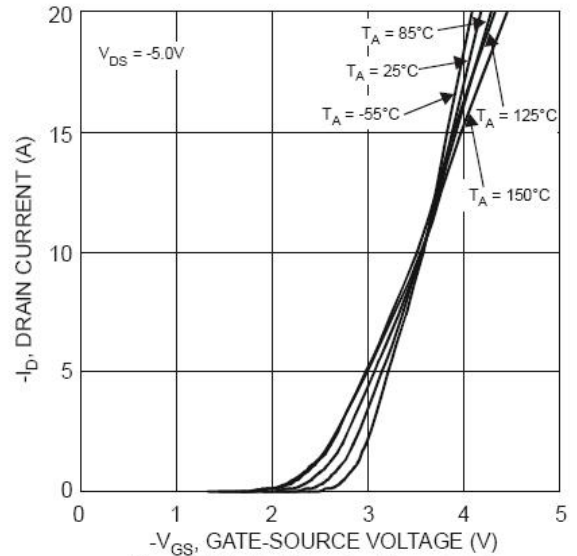

Figure 2 Typical Transfer Characteristics

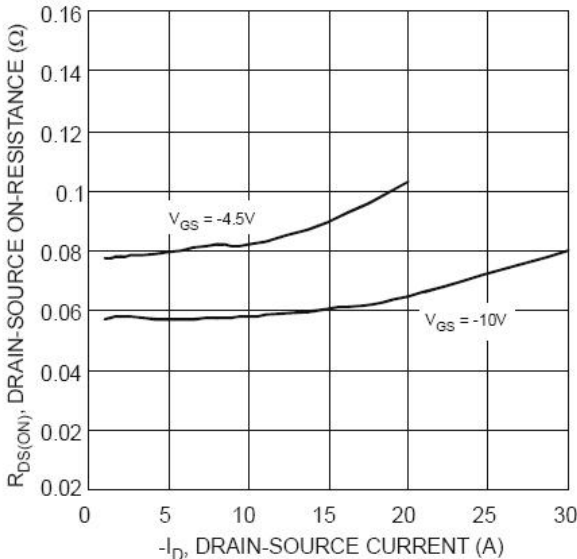

Figure 3 Typical On-Resistance vs. Drain Current and Gate Voltage

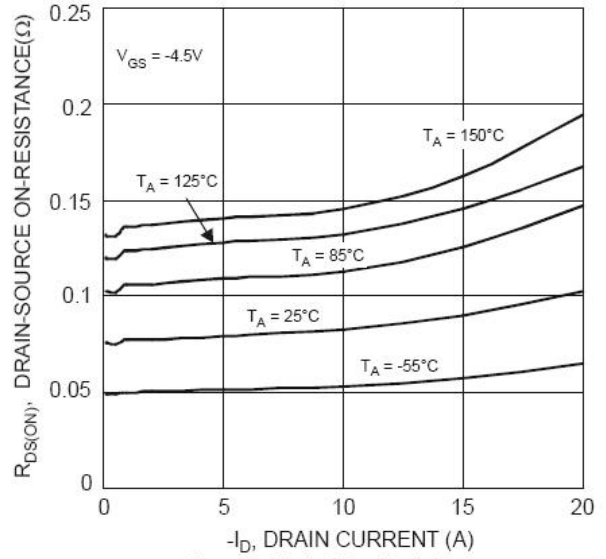

Figure 4 Typical On-Resistance vs. Drain Current and Temperature

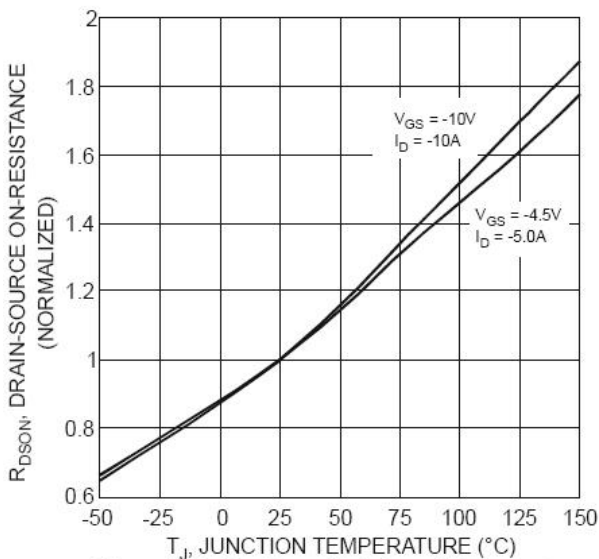

Figure 5 On-Resistance Variation with Temperature

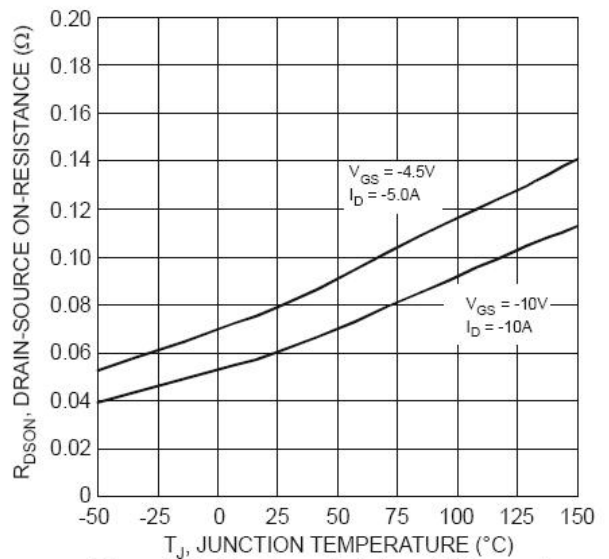

Figure 6 On-Resistance Variation with Temperature

Typical Characteristics at $T_a=25^{\circ}\text{C}$ (Continued)

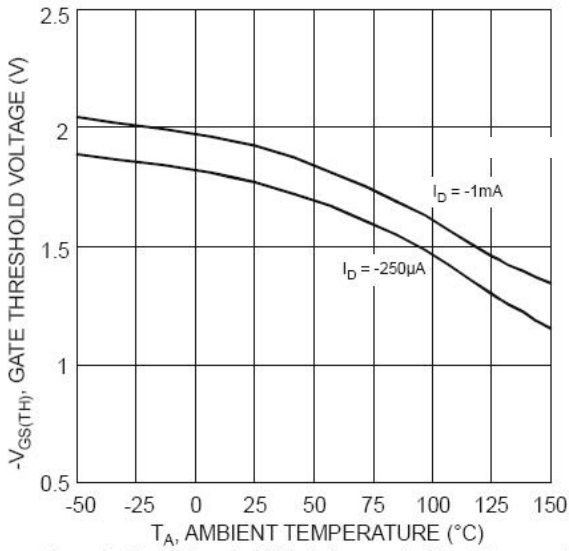

Figure 7 Gate Threshold Variation vs. Ambient Temperature

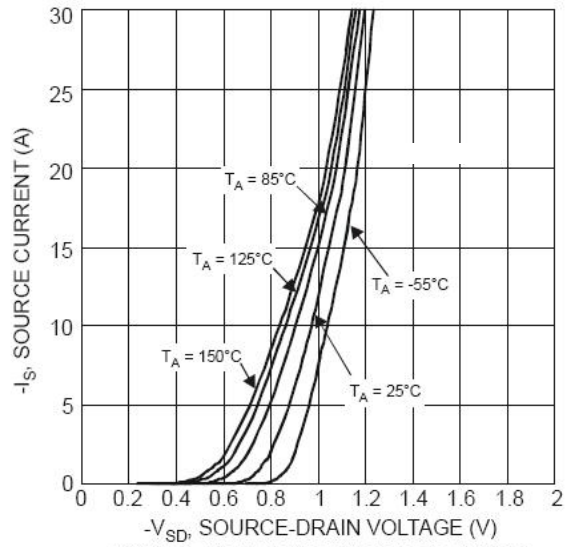

Figure 8 Diode Forward Voltage vs. Current

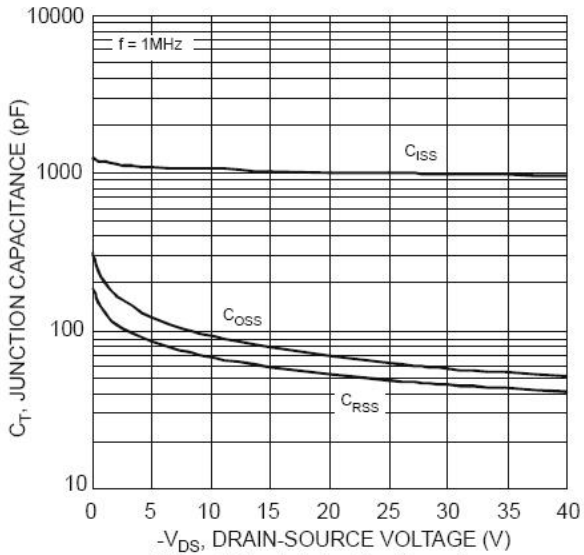

Figure 9 Typical Junction Capacitance

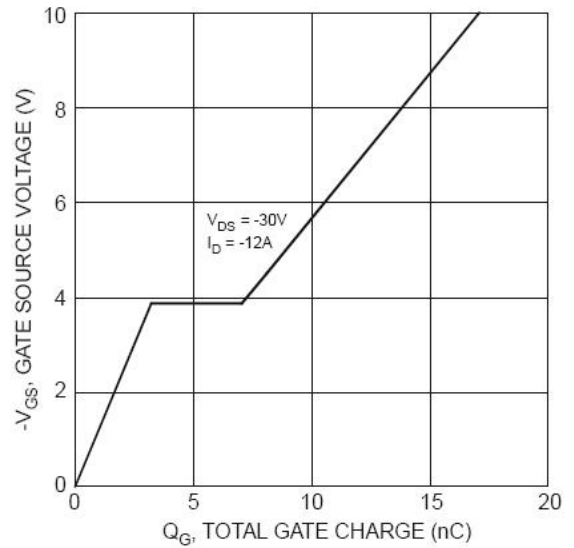

Figure 10 Gate Charge Characteristics