

### Features

- Low On resistance.
- $\pm 4.5V$  drive.
- RoHS compliant.



### Package Dimensions

unit : mm  
SOP-8

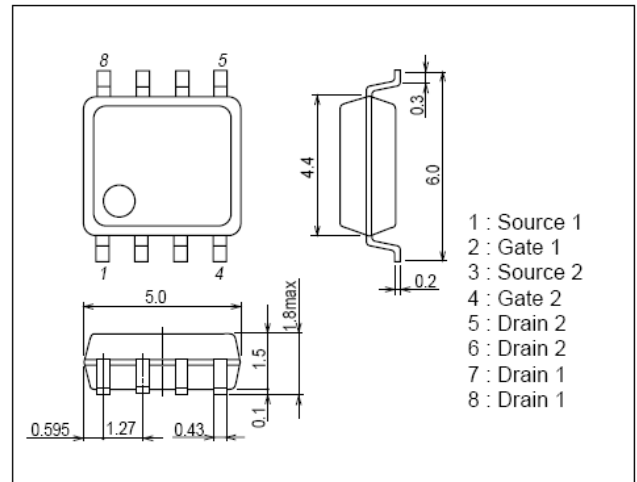

### Specifications

**Absolute Maximum Ratings** at  $T_a=25^{\circ}C$

Parameter	Symbol	Conditions	Ratings		Unit
			N-Ch	P-Ch	
Drain-to-Source Voltage	$V_{DSS}$	Drain-Source Voltage	30	-30	V
Gate-to-Source Voltage	$V_{GSS}$	Gate-Source Voltage	$\pm 20$	$\pm 20$	V
Drain Current (DC)	$I_D$	Continuous Drain Current	6.9	-6	A
Drain Current (Pulse)	$I_{DP}$	$PW \leq 10\mu s$ , duty cycle $\leq 1\%$	30	-30	A
Allowable Power Dissipation	$P_D$	Mounted on a ceramic board (1000mm <sup>2</sup> × 0.8mm) 1unit	1.3	1.3	W
Total Dissipation	$P_T$	Mounted on a ceramic board (1000mm <sup>2</sup> × 0.8mm)	1.7	1.7	W
Channel Temperature	$T_{ch}$	Maximum Junction Temperature	150		$^{\circ}C$
Storage Temperature	$T_{stg}$	Storage Temperature Range	-55~+150		$^{\circ}C$

### Pin Description

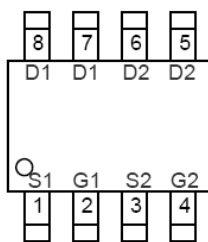

TOP VIEW  
SOP-8

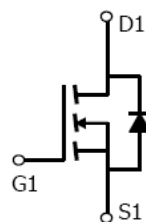

n-channel

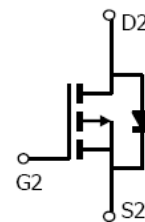

p-channel

**N-Channel Electrical Characteristics at  $T_a=25^{\circ}\text{C}$**

Parameter	Symbol	Conditions	Ratings			Unit
			min	typ	max	
Drain-to-Source Breakdown Voltage	$V_{(BR)DSS}$	$I_D=250\mu\text{A}, V_{GS}=0\text{V}$	30			V
Zero-Gate Voltage Drain Current	$I_{DSS}$	$V_{DS}=24\text{V}, V_{GS}=0\text{V}$			1	$\mu\text{A}$
Gate-to-Source Leakage Current	$I_{GSS}$	$V_{GS}=\pm 20\text{V}, V_{DS}=0\text{V}$			$\pm 100$	nA
Gate Threshold Voltage	$V_{GS(th)}$	$V_{DS}=V_{GS}, I_D=250\mu\text{A}$	1.0	1.6	2.0	V
Static Drain-to-Source On-State Resistance	$R_{DS(ON)}$	$I_D=6.9\text{A}, V_{GS}=10\text{V}$		20	28	$\text{m}\Omega$
	$R_{DS(ON)}$	$I_D=5\text{A}, V_{GS}=4.5\text{V}$		30	40	$\text{m}\Omega$
Input Capacitance	$C_{iss}$	$V_{DS}=15\text{V}, V_{GS}=0\text{V}, f=1\text{MHz}$		680	820	pF
Output Capacitance	$C_{oss}$	$V_{DS}=15\text{V}, V_{GS}=0\text{V}, f=1\text{MHz}$		102		pF
Reverse Transfer Capacitance	$C_{rss}$	$V_{DS}=15\text{V}, V_{GS}=0\text{V}, f=1\text{MHz}$		77		pF
Turn-on Delay Time	$t_{d(on)}$	$V_{GS}=10\text{V}, V_{DS}=15\text{V}, R_L=2.2\Omega,$ $R_{GEN}=3\Omega$		4.6	7	nS
Rise Time	$t_r$			4.1	6	nS
Turn-off Delay Time	$t_{d(off)}$			20.6	30	nS
Fall Time	$t_f$			5.2	8	nS
Total Gate Charge	$Q_g$	$V_{DS}=15\text{V}, V_{GS}=10\text{V}, I_D=6.9\text{A}$		6.74	8.1	nC
Gate-to-Source Charge	$Q_{gs}$			1.82		nC
Gate-to-Drain "Miller" Charge	$Q_{gd}$			3.2		nC
Diode Forward Voltage	$V_{SD}$	$I_S=1\text{A}, V_{GS}=0\text{V}$		0.76	1.3	V

**N-Channel Typical Characteristics at  $T_a=25^{\circ}\text{C}$**

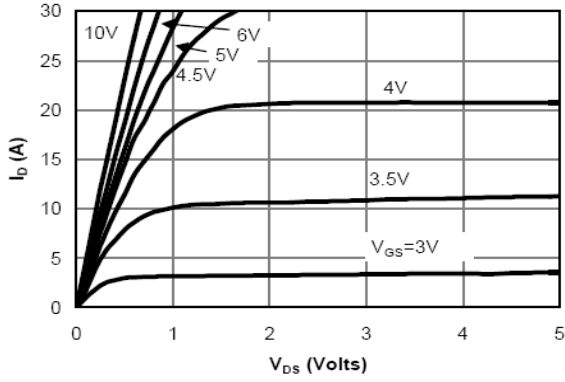

Fig 1: On-Region Characteristics

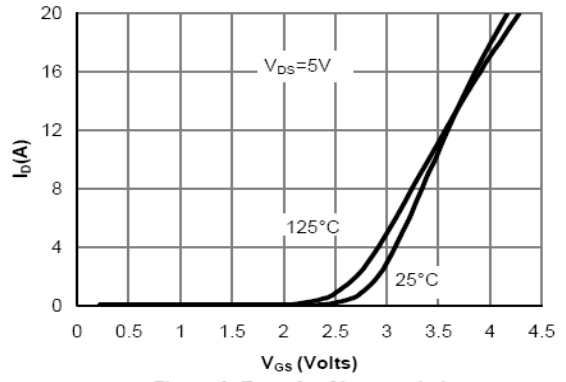

Figure 2: Transfer Characteristics

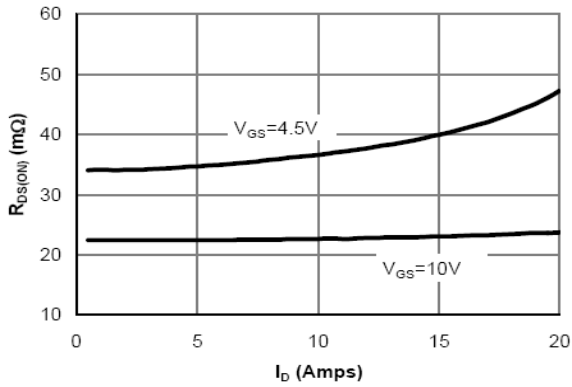

Figure 3: On-Resistance vs. Drain Current and Gate Voltage

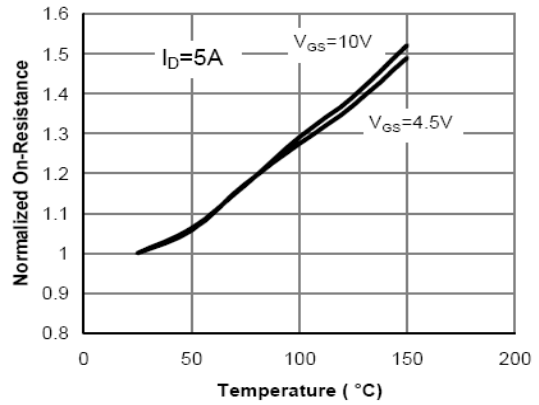

Figure 4: On-Resistance vs. Junction Temperature

N-Channel Typical Characteristics at  $T_a=25^{\circ}\text{C}$  (Continues)

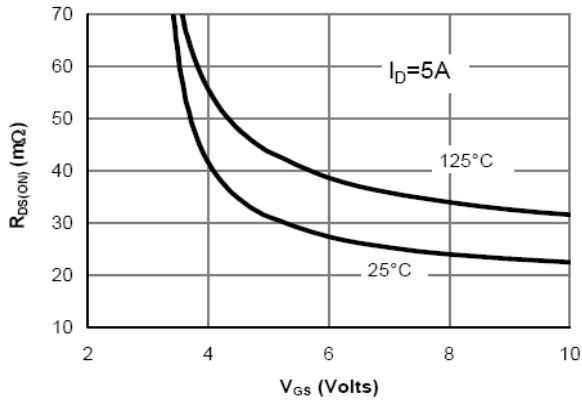

Figure 5: On-Resistance vs. Gate-Source Voltage

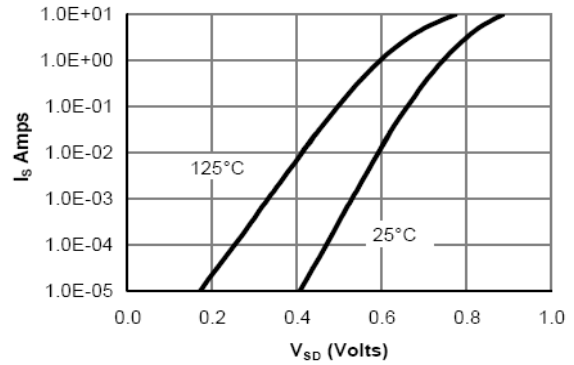

Figure 6: Body diode characteristics

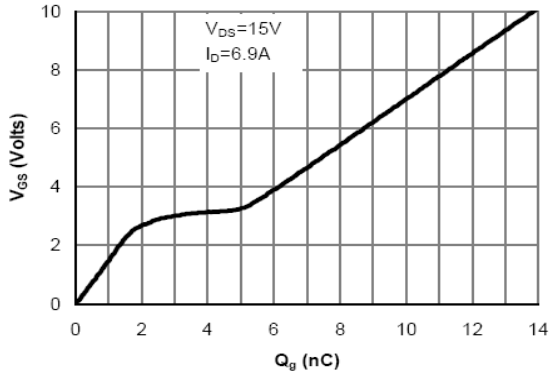

Figure 7: Gate-Charge characteristics

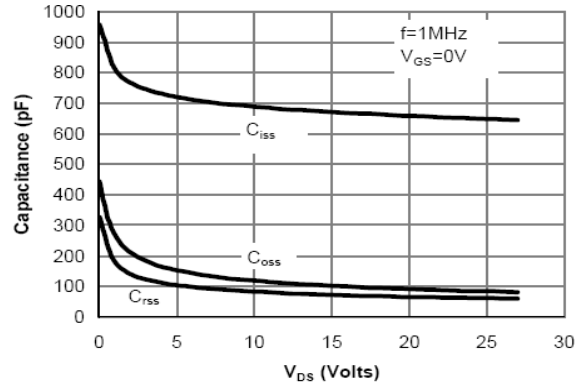

Figure 8: Capacitance Characteristics

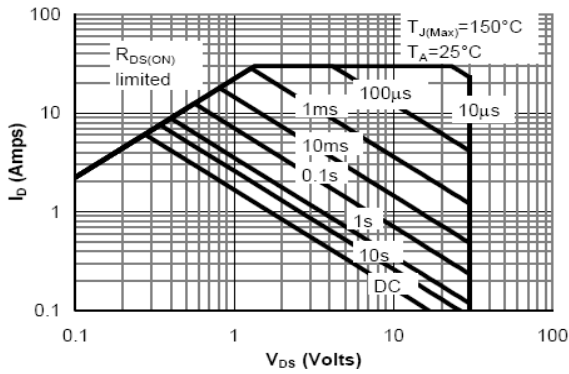

Figure 9: Maximum Forward Biased Safe Operating Area (Note E)

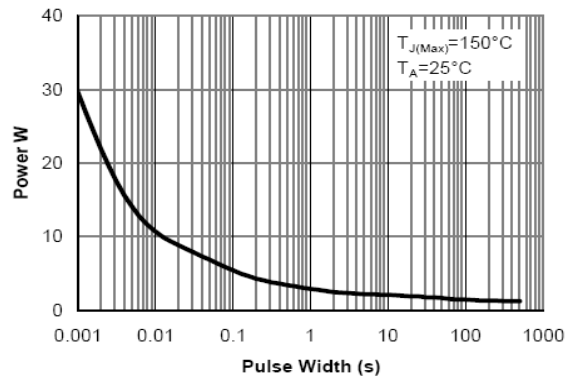

Figure 10: Single Pulse Power Rating Junction-to-Ambient (Note E)

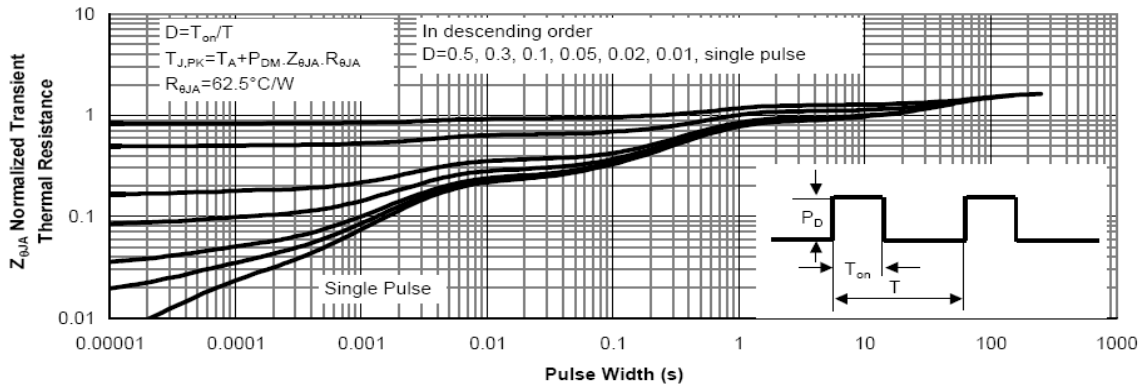

Figure 11: Normalized Maximum Transient Thermal Impedance

**P-Channel Electrical Characteristics at  $T_a=25^0C$**

Parameter	Symbol	Conditions	Ratings			Unit
			min	typ	max	
Drain-to-Source Breakdown Voltage	$V_{(BR)DSS}$	$I_D=-250\mu A, V_{GS}=0V$	-30			V
Zero-Gate Voltage Drain Current	$I_{DSS}$	$V_{DS}=-24V, V_{GS}=0V$			-1	$\mu A$
Gate-to-Source Leakage Current	$I_{GSS}$	$V_{GS}=\pm 20V, V_{DS}=0V$			$\pm 100$	nA
Gate Threshold Voltage	$V_{GS(th)}$	$V_{DS}=V_{GS}, I_D=250\mu A$	-1.0	-1.4	-2.0	V
Static Drain-to-Source On-State Resistance	$R_{DS(ON)}$	$I_D=-6A, V_{GS}=-10V$		28	35	$m\Omega$
	$R_{DS(ON)}$	$I_D=-5A, V_{GS}=-4.5V$		50	65	$m\Omega$
Input Capacitance	$C_{iss}$	$V_{DS}=-15V, V_{GS}=0V, f=1MHz$		920	1100	pF
Output Capacitance	$C_{oss}$	$V_{DS}=-15V, V_{GS}=0V, f=1MHz$		190		pF
Reverse Transfer Capacitance	$C_{rss}$	$V_{DS}=-15V, V_{GS}=0V, f=1MHz$		122		pF

Turn-on Delay Time	$t_{d(on)}$	$V_{GS}=-10V, V_{DS}=-15V, R_L=2.7\Omega,$ $R_{GEN}=3\Omega$	7.7	11.5	nS
Rise Time	$t_r$		5.7	8.5	nS
Turn-off Delay Time	$t_{d(off)}$		20.2	30	nS
Fall Time	$t_f$		9.5	14	nS
Total Gate Charge	$Q_g$	$V_{DS}=-15V, V_{GS}=-10V, I_D=-6A$	9.6	11.6	nC
Gate-to-Source Charge	$Q_{gs}$		2.7	11.6	nC
Gate-to-Drain "Miller" Charge	$Q_{gd}$		4.5		nC
Diode Forward Voltage	$V_{SD}$	$I_S=-1A, V_{GS}=0V$	-0.8	-1.3	V

### P-Channel Typical Characteristics at $T_a=25^{\circ}C$

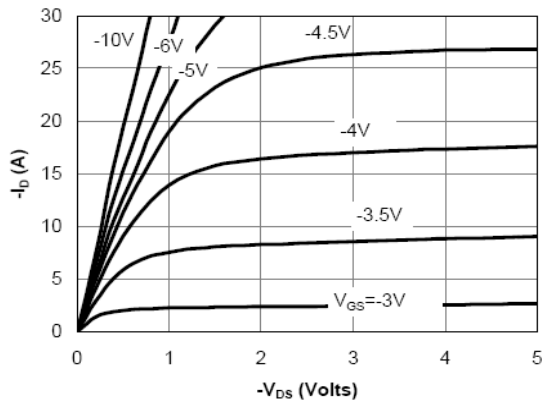

Fig 1: On-Region Characteristics

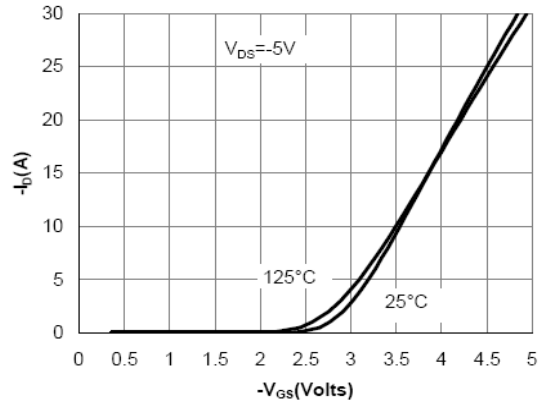

Figure 2: Transfer Characteristics

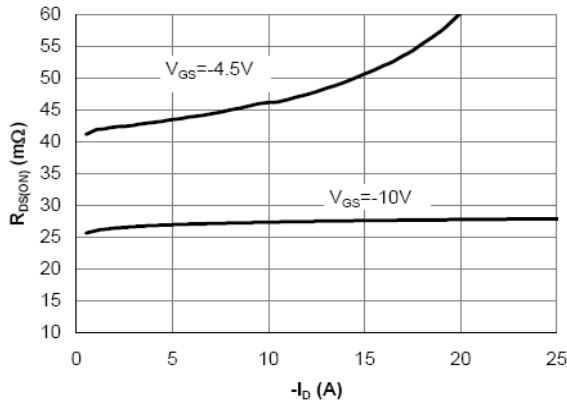

Figure 3: On-Resistance vs. Drain Current and Gate Voltage

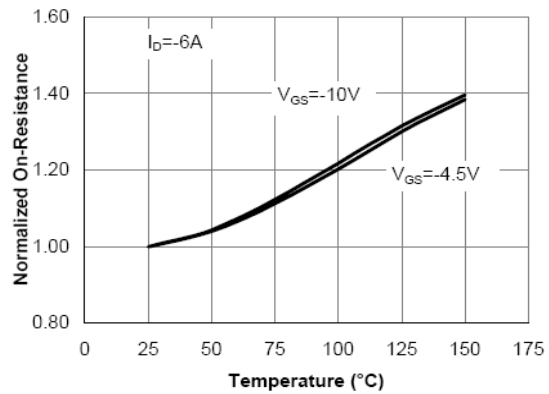

Figure 4: On-Resistance vs. Junction Temperature

### P-Channel Typical Characteristics at $T_a=25^{\circ}C$ (Continues)

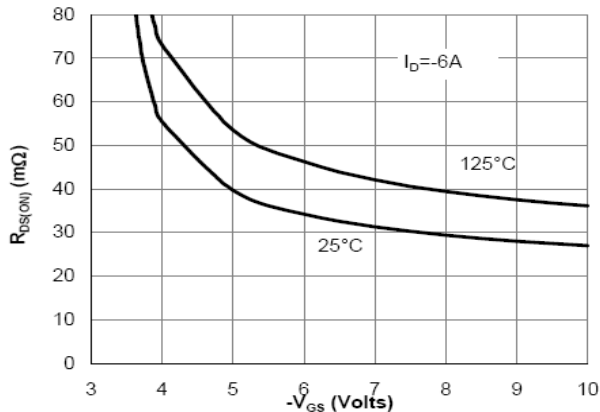

Figure 5: On-Resistance vs. Gate-Source Voltage

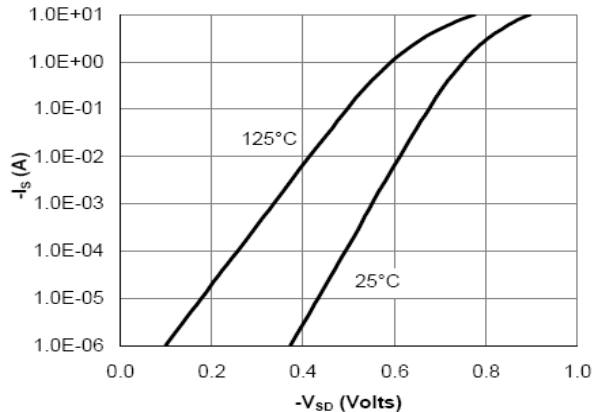

Figure 6: Body-Diode Characteristics

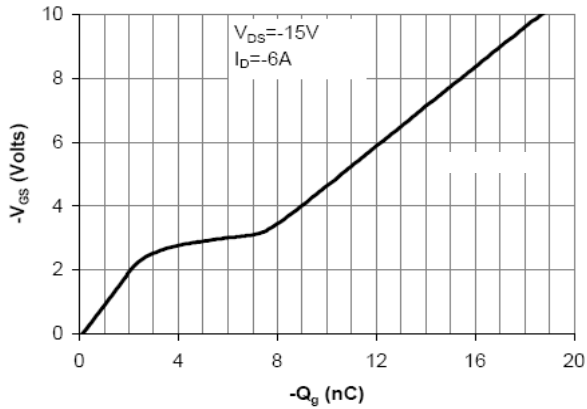

Figure 7: Gate-Charge Characteristics

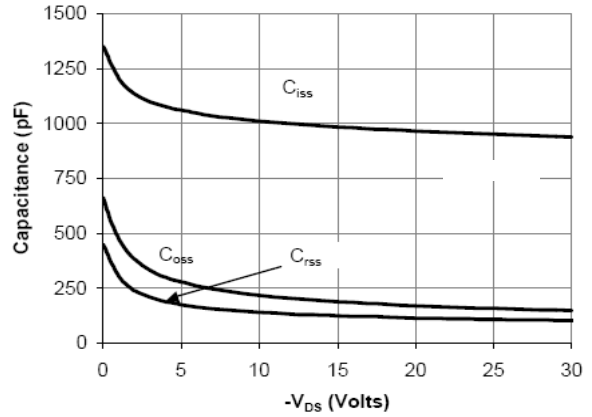

Figure 8: Capacitance Characteristics

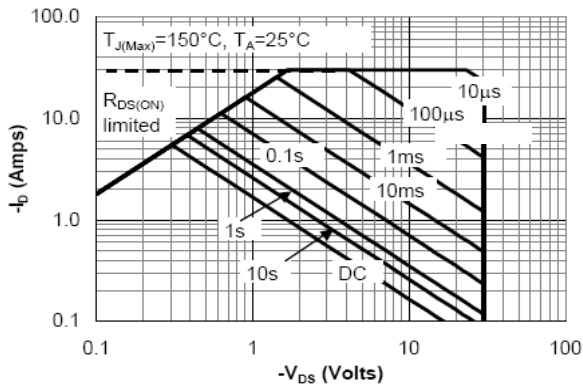

Figure 9: Maximum Forward Biased Safe Operating Area (Note E)

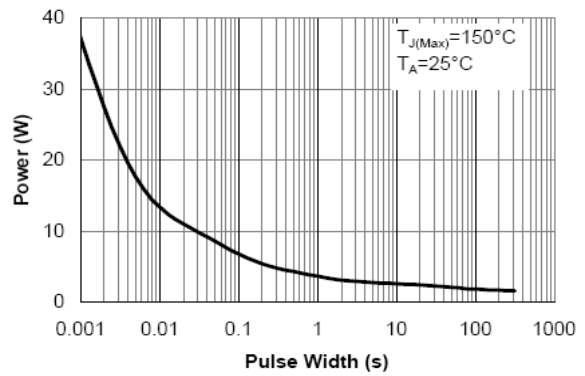

Figure 10: Single Pulse Power Rating Junction-to-Ambient (Note E)

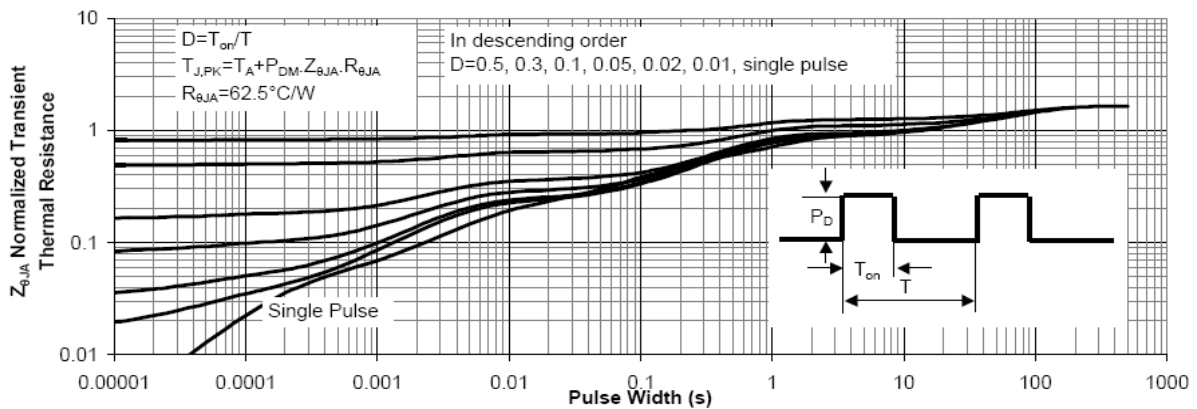

Figure 11: Normalized Maximum Transient Thermal Impedance