

Features

- Low On resistance.
- 4.5V drive.
- RoHS compliant.



Package Dimensions

unit : mm
SOP-8

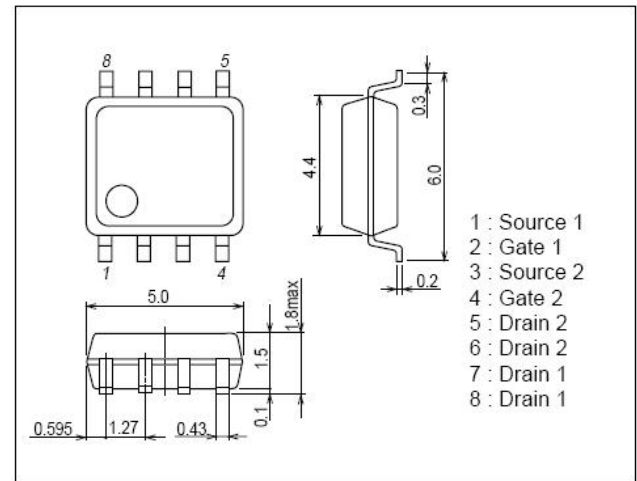

Specifications

Absolute Maximum Ratings at $T_a=25^{\circ}\text{C}$

Parameter	Symbol	Conditions	Ratings	Unit
Drain-to-Source Voltage	V_{DSS}		60	V
Gate-to-Source Voltage	V_{GSS}		± 20	V
Drain Current (DC)	I_D		7	A
Drain Current (Pulse)	I_{DP}	$PW \leq 10\mu\text{S}$, duty cycle $\leq 1\%$	20	A
Allowable Power Dissipation	P_D	Mounted on a ceramic board (1000mm ² ×0.8mm) 1unit	1.3	W
Total Dissipation	P_T	Mounted on a ceramic board (1000mm ² ×0.8mm)	1.7	W
Channel Temperature	T_{ch}		150	$^{\circ}\text{C}$
Storage Temperature	T_{stg}		-55~+150	$^{\circ}\text{C}$

Electrical Characteristics at $T_a=25^{\circ}\text{C}$

Parameter	Symbol	Conditions	Ratings			Unit
			min	typ	max	
Drain-to-Source Breakdown Voltage	$V_{(BR)DSS}$	$I_D=250\mu\text{A}$, $V_{GS}=0\text{V}$	60	-	-	V
Zero-Gate Voltage Drain Current	I_{DSS}	$V_{DS}=60\text{V}$, $V_{GS}=0\text{V}$	-	-	1	μA
Gate-to-Source Leakage Current	I_{GSS}	$V_{GS}=\pm 20\text{V}$, $V_{DS}=0\text{V}$	-	-	± 100	nA
Gate Threshold Voltage	$V_{GS(th)}$	$V_{DS}=V_{GS}$, $I_D=250\mu\text{A}$	1.2	2.0	2.5	V
Static Drain-to-Source On-State Resistance	$R_{DS(ON)}$	$I_D=7\text{A}$, $V_{GS}=10\text{V}$	-	32	38	m Ω
	$R_{DS(ON)}$	$I_D=2\text{A}$, $V_{GS}=1.8\text{V}$	-	38	52	m Ω
Input Capacitance	C_{iss}	$V_{DS}=25\text{V}$, $V_{GS}=0\text{V}$, $f=1\text{MHz}$	-	450	-	pF
Output Capacitance	C_{oss}	$V_{DS}=25\text{V}$, $V_{GS}=0\text{V}$, $f=1\text{MHz}$	-	60	-	pF
Reverse Transfer Capacitance	C_{rss}	$V_{DS}=25\text{V}$, $V_{GS}=0\text{V}$, $f=1\text{MHz}$	-	25	-	pF

Si4946

Electrical Characteristics at $T_a=25^{\circ}\text{C}$ (Continued)

Parameter	Symbol	Conditions	Ratings			Unit
			min	Typ	max	
Turn-on Delay Time	$t_{d(on)}$	$V_{GS}=5\text{V}, V_{DS}=30\text{V}, I_D=4.5\text{A}$ $R_{GEN}=3\Omega$	-	4.7	-	nS
Rise Time	t_r		-	2.3	-	nS
Turn-off Delay Time	$t_{d(off)}$		-	15.7	-	nS
Fall Time	t_f		-	1.9	-	nS
Total Gate Charge	Q_g	$V_{DS}=30\text{V}, V_{GS}=10\text{V}, I_D=4.5\text{A}$	-	8.5	-	nC
Gate-to-Source Charge	Q_{gs}		-	1.6	-	nC
Gate-to-Drain "Miller" Charge	Q_{gd}		-	2.2	-	nC
Diode Forward Voltage	V_{SD}	$I_S=3.7\text{A}, V_{GS}=0\text{V}$	-	-	1.2	V

Pin Description

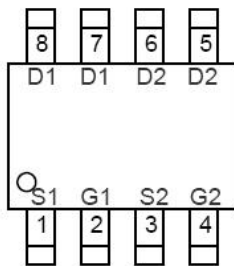

TOP VIEW
SOP-8

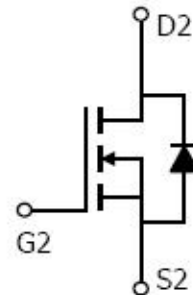
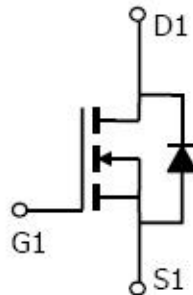

Typical Characteristics at $T_a=25^{\circ}\text{C}$

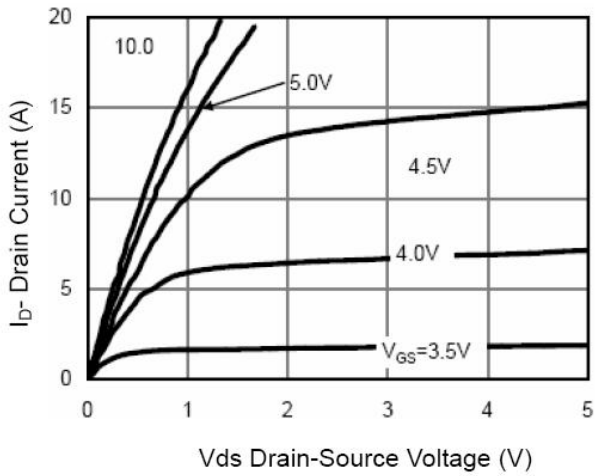

Figure 1 Output Characteristics

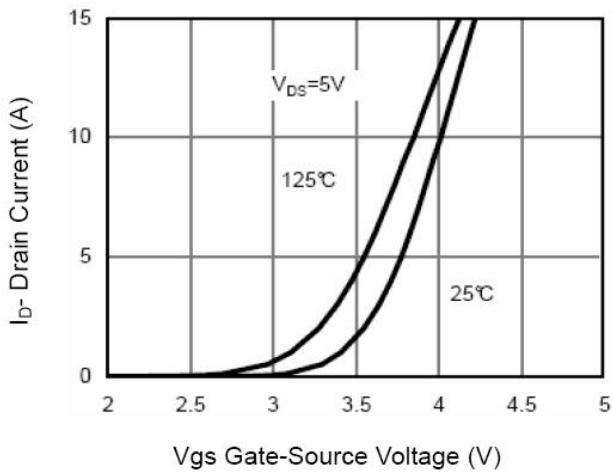

Figure 2 Transfer Characteristics

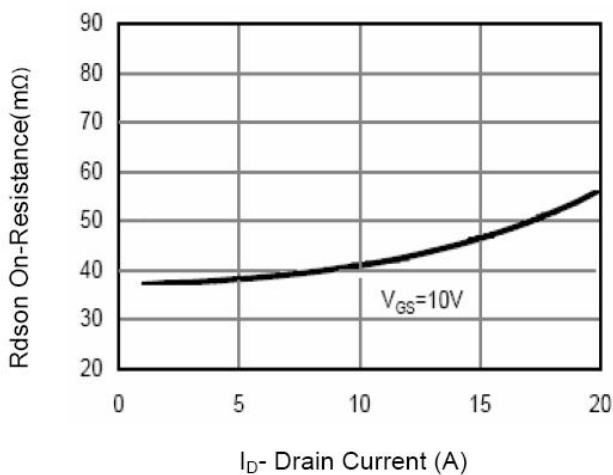

Figure 3 $R_{DS(on)}$ - Drain Current

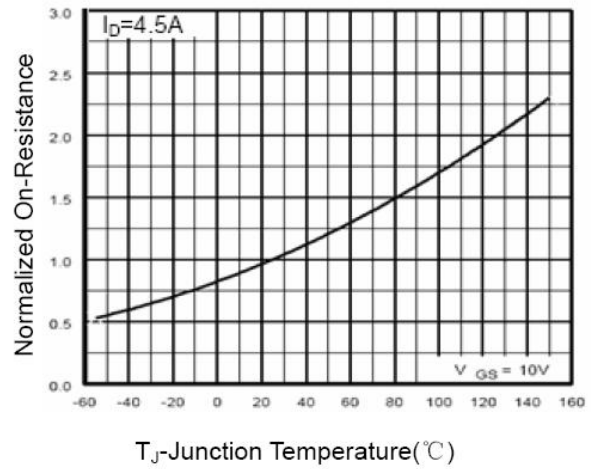

Figure 4 $R_{DS(on)}$ -Junction Temperature

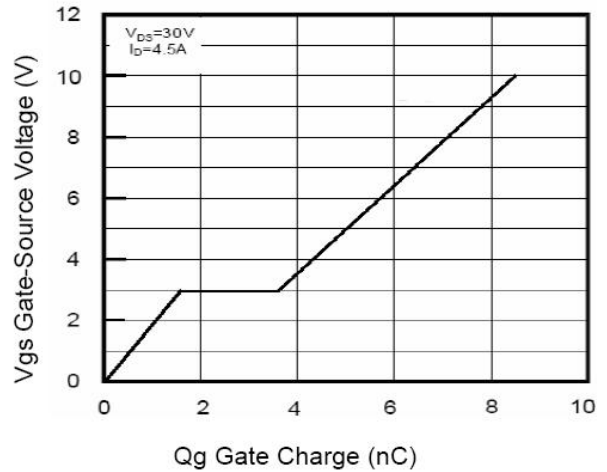

Figure 5 Gate Charge

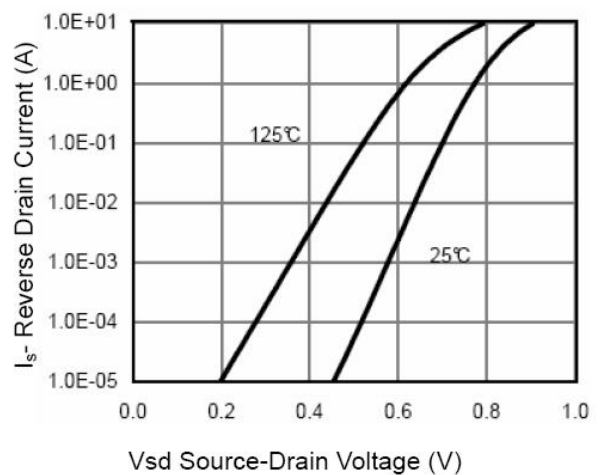

Figure 6 Source- Drain Diode Forward

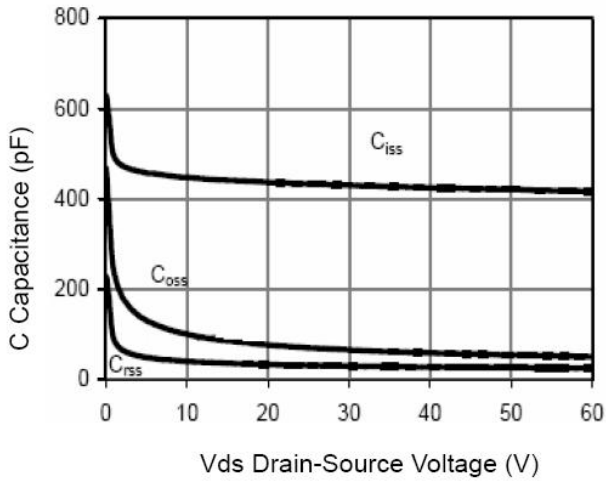

Figure 7 Capacitance vs Vds

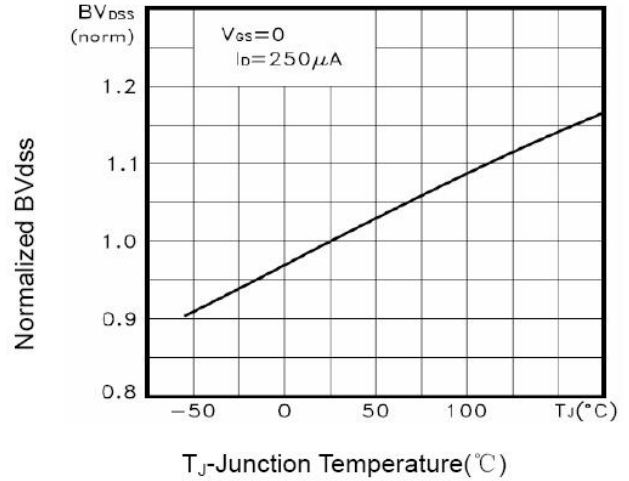

Figure 9 BV_{DSS} vs Junction Temperature

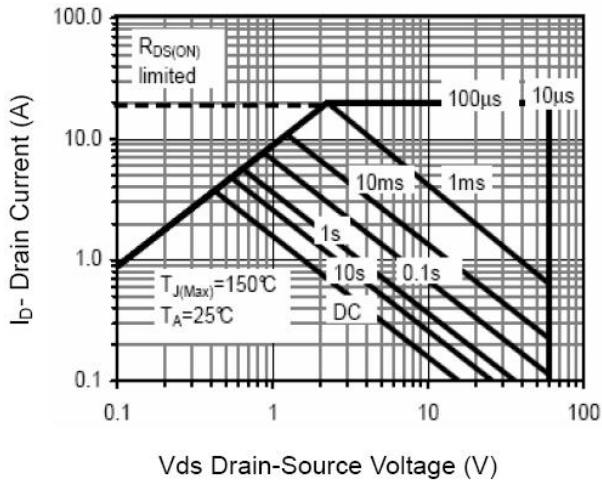

Figure 8 Safe Operation Area

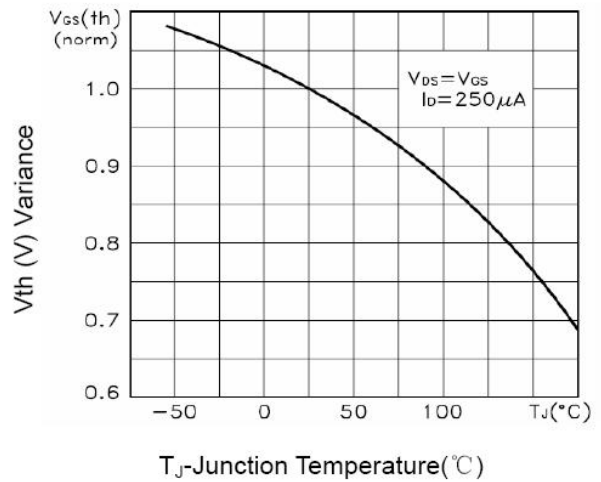

Figure 10 $V_{GS(th)}$ vs Junction Temperature

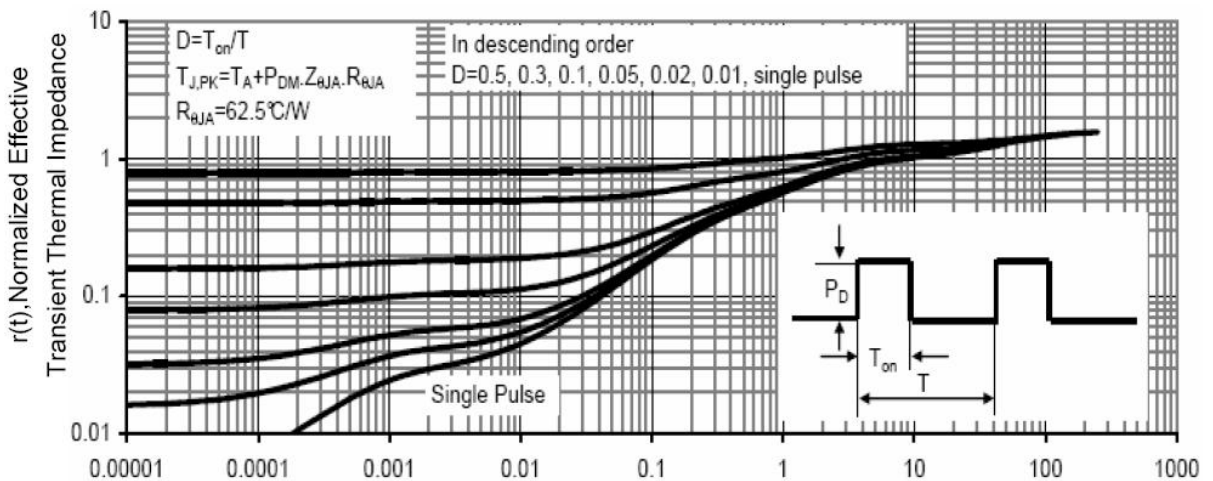

Figure 11 Normalized Maximum Transient Thermal Impedance